

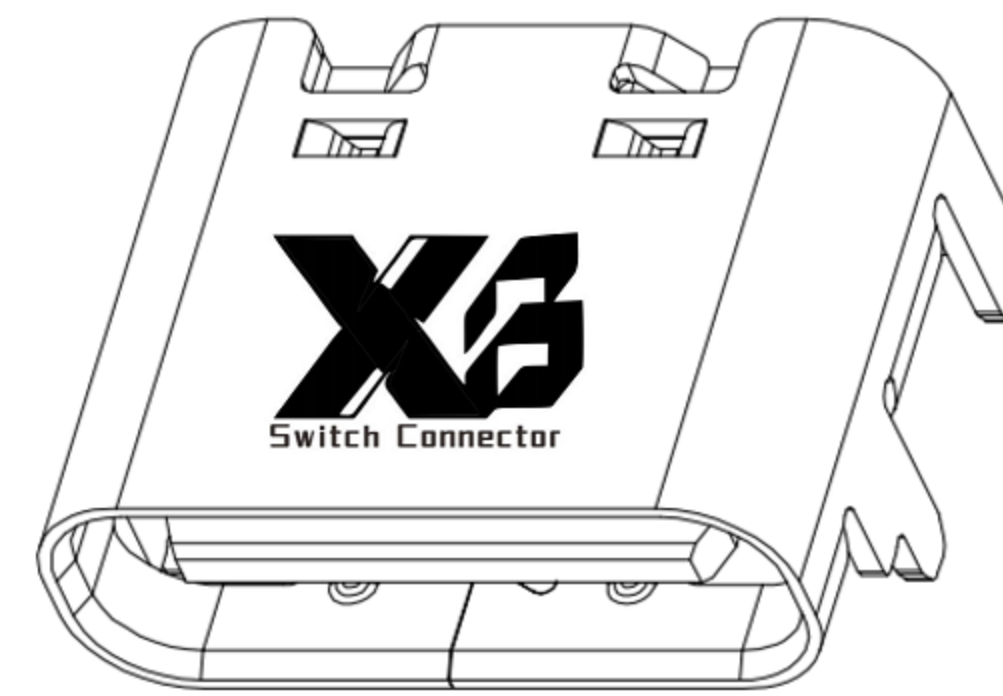

鍍層厚度:

Blank : 1u"
2 : 15u"
3 : 30u"

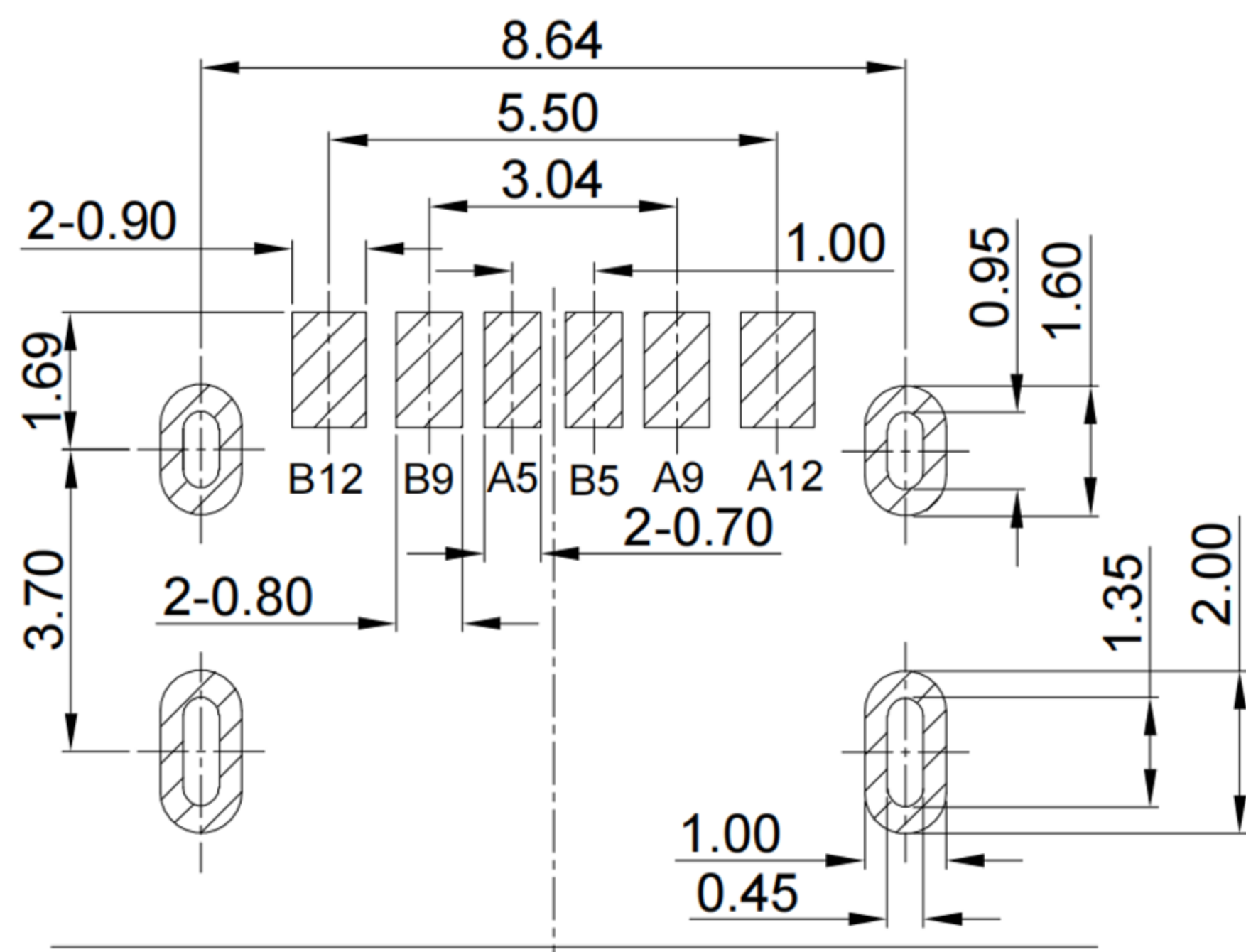
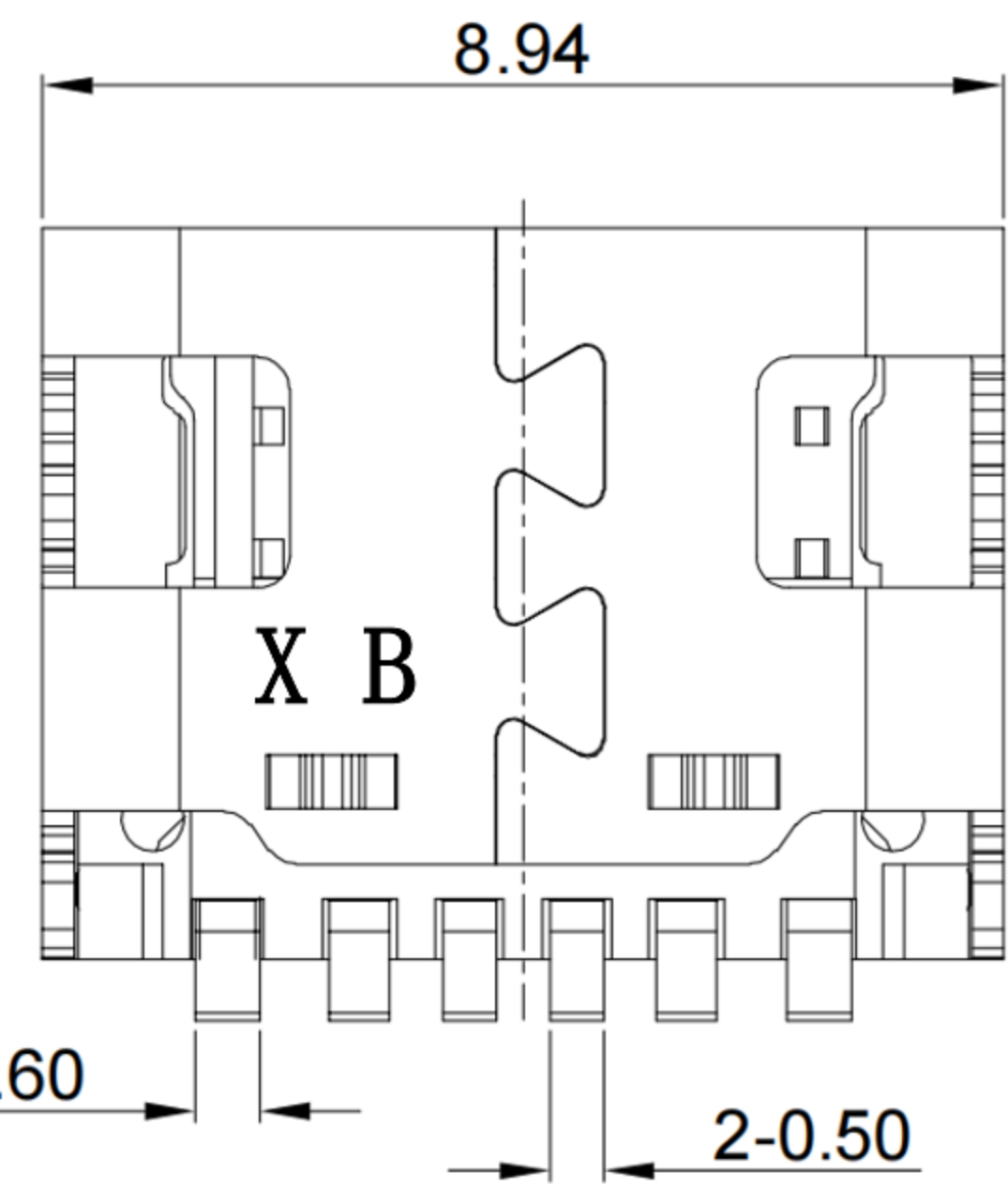
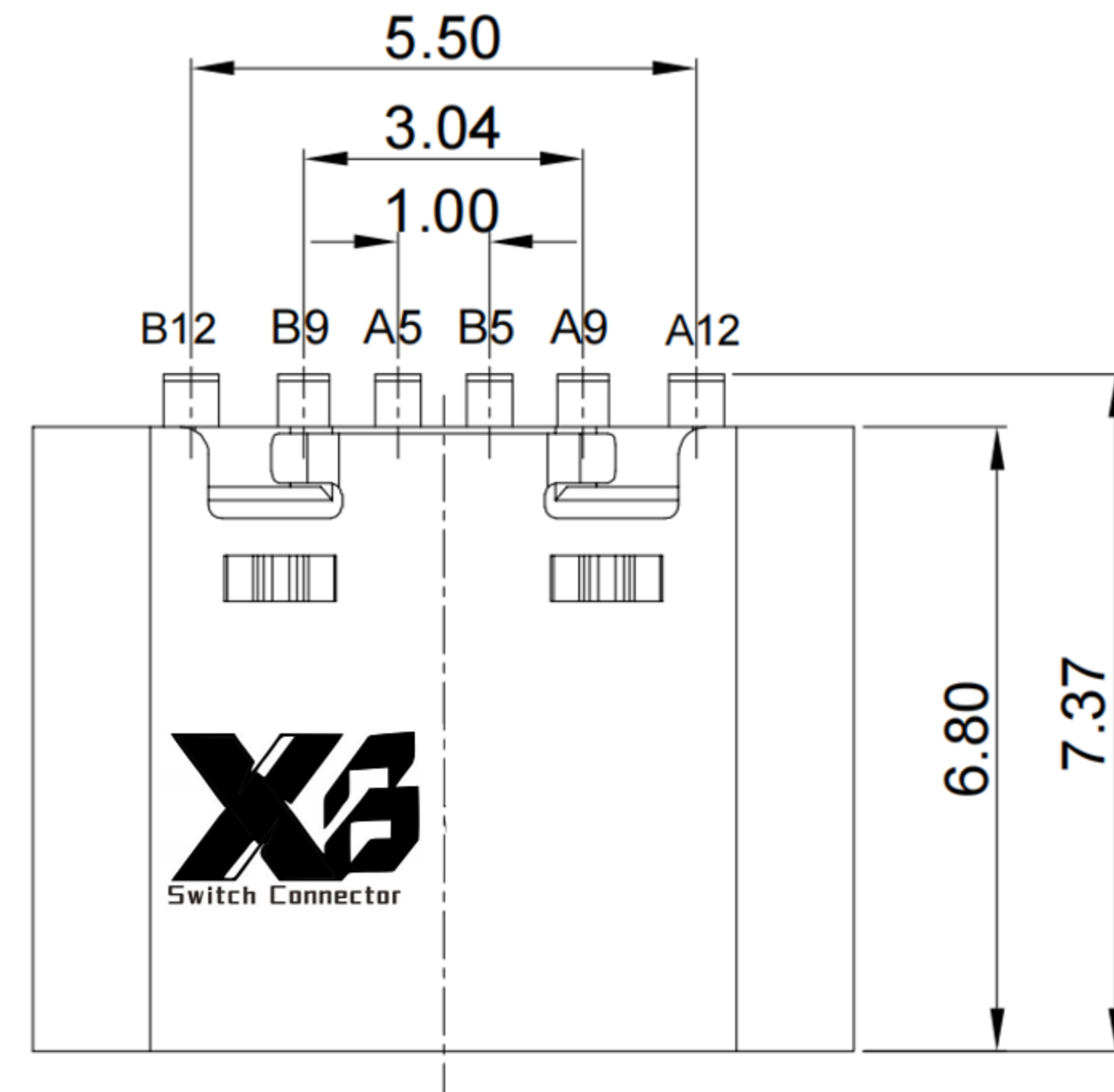
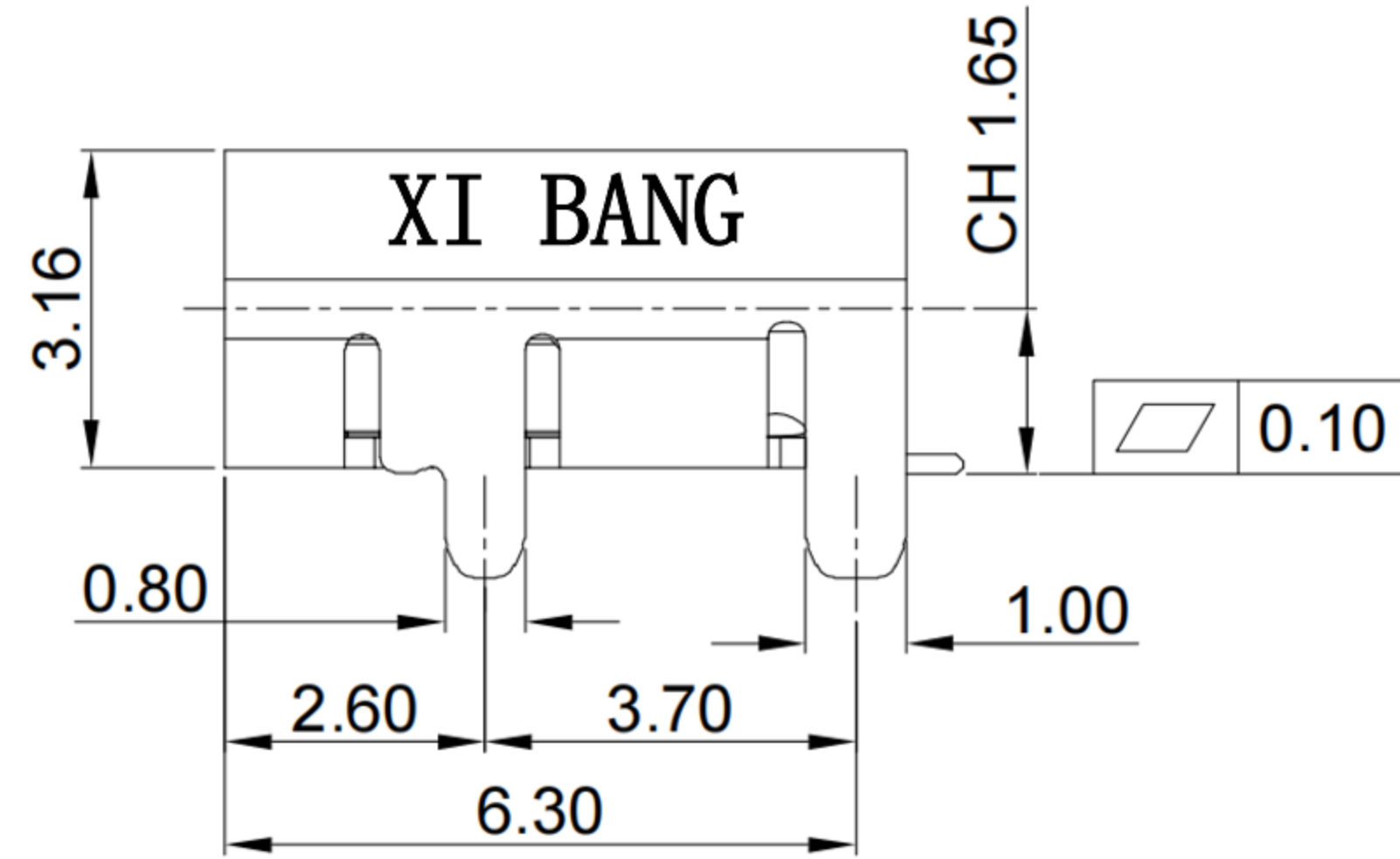
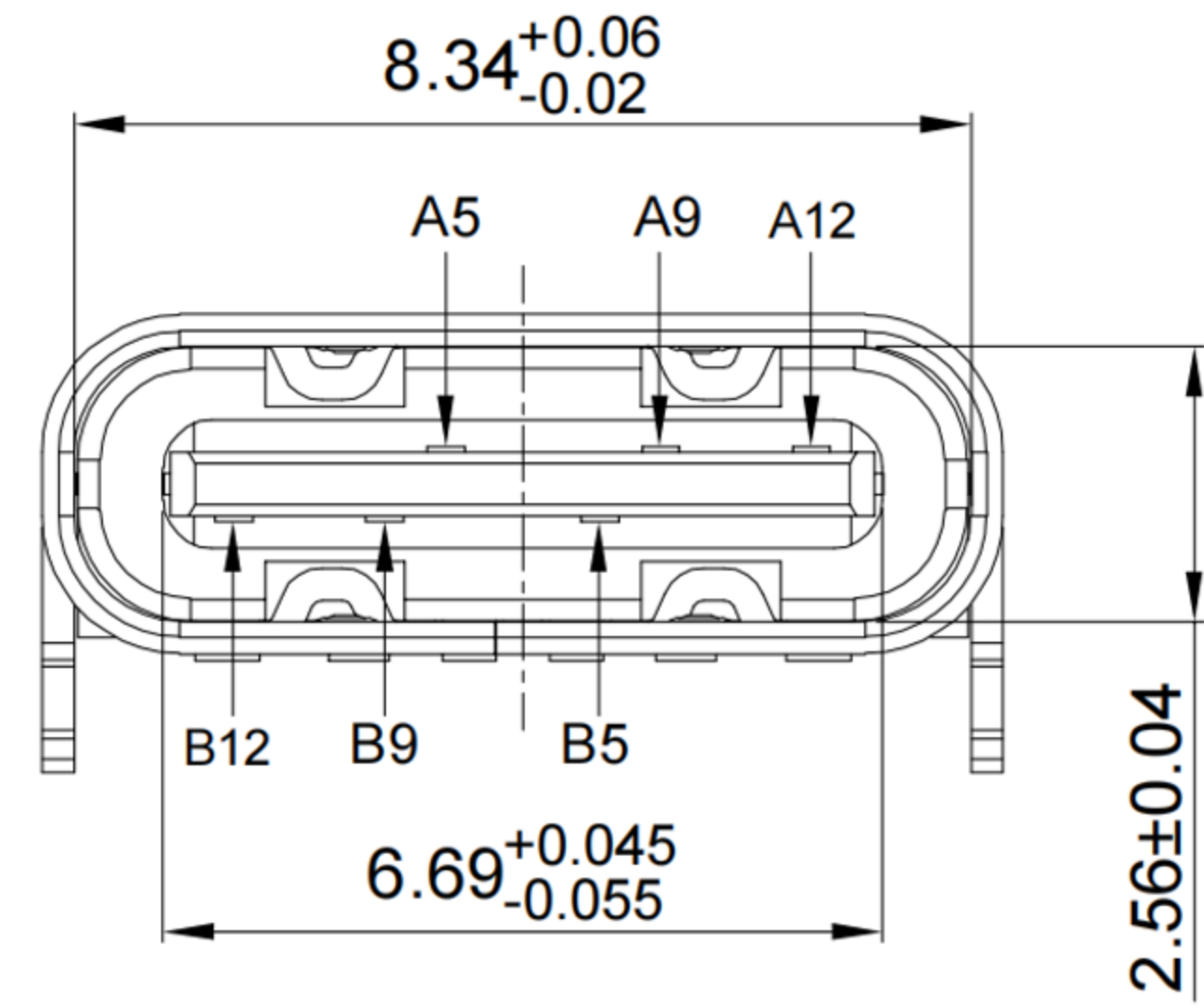

RECOMMENDED P.C.B. LAYOUT
TOLERANCE UNSPECIFIED ±0.05mm

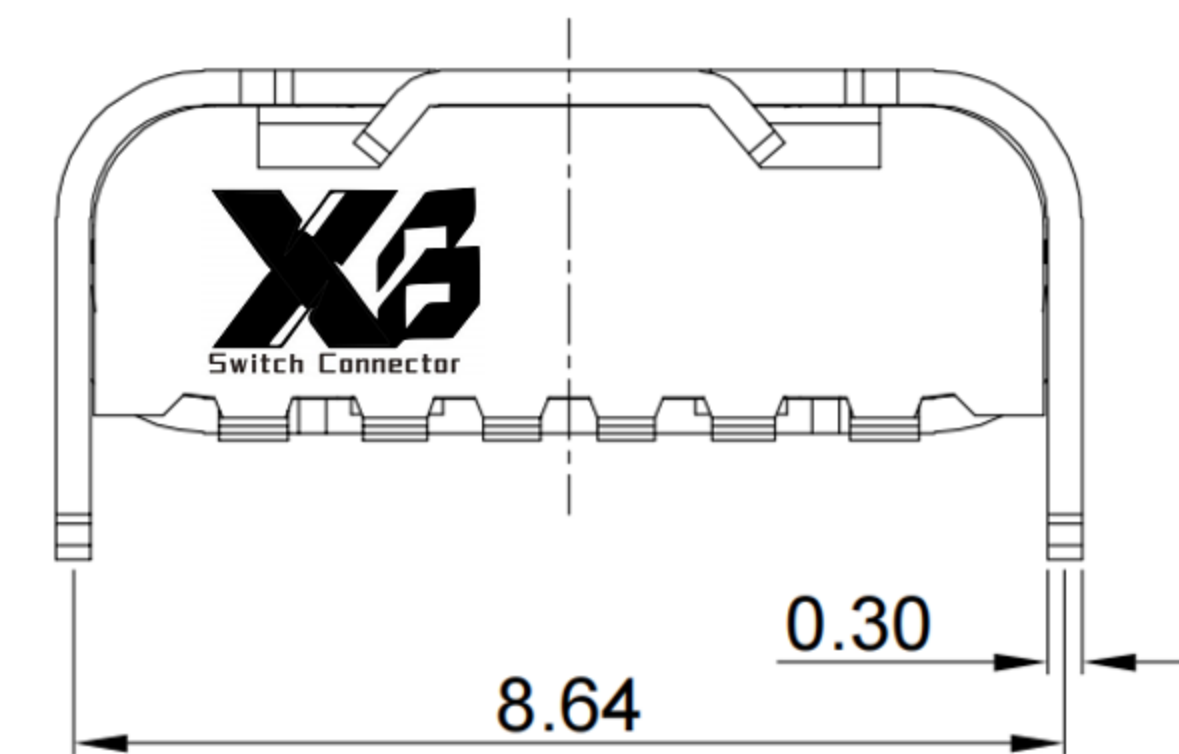

A1	A2	A3	A4	A5	A6	A7	A8	A9	A10	A11	A12
				CC1				VBUS			GND
				Second				First			First
B12	B11	B10	B9	B8	B7	B6	B5	B4	B3	B2	B1
GND			VBUS				CC2				
First			First				Second				

SPECIFICATIONS

Electrical:

1. Rating: 5.0A (V BUS&GND), 0.25A (Other Pin)
2. Voltage rating: 12V 24V AC
3. Contact Resistance: 40 mΩ Max
4. Insulation Resistance: 100 MΩ Min
5. Dielectric Withstanding Voltage: 100V AC
6. Operating temperature: -40° C ~ +85° C
7. Waterproof grade: IP 50
8. Durability cycle: 10,000 cycles

Mechanical:

1. Connector Mate and Unmate Force
 - 1.1 Mate force: 5~20 N .
 - 1.2 Unmate force: 8~20 N

Material:

1. Housing: LCP
2. Contact: C18400
3. Shell: SUS
4. O-ring: Silicone

Finish:

1. Contact: Plated Gold in Mating Area ; Tin Plated on Solder Balls ; Nickel under plated overall
2. Shell: Nickel under Plated surface layer

XB 东莞市溪榜电子有限公司
DONG GUAN XI BANG ELECTRONICS CO., LTD.

TOLERANCE UNLESS OTHERWISE STATED:
 Up to 5 ±0.2
 Above 5 ~ 15 ±0.3
 Above 15 ~ 30 ±0.4
 Above 30 ~ 50 ±0.5
 Angle ±0.3°

3RD. ANGEL'S

UNITS MM

DRAWN BY:	DATE	MAT'L	TITLE	CONNECTOR
Jack Lu	03/10/22			
CHECKED BY:	DATE	FINISH	MODLE	Horizontal Type-c 6P Female SMT CH=1.65 L=6.8mm
Jacky Chen	03/10/22			
APPROVED BY:	DATE	SCALE	DWG NO.	XB-USB-C-0603
Tony Kao	03/10/22	1:1	PART NO.	
		SHEET NO.	1 of 1	

1	更新圖面	Jack	031022
ITEM NO.	DESCRIPTION	DRAWN	DATE