

Infrared Receiver Module IRM-6638T Datasheet

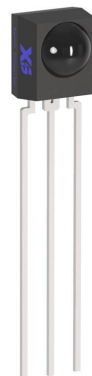

Pin Configuration

1. OUT
2. GND
3. Vcc

Block Diagram

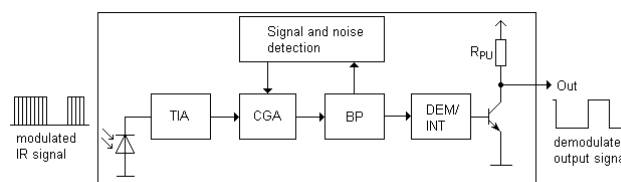

Features

- High protection ability against EMI
- Circular lens for improved reception characteristics
- Available for various carrier frequencies
- min burst length: 12 cycles
- min gap length: 16 cycles
- Low operating voltage and low power consumption
- High immunity against ambient light
- High immunity against TFT and PDP backlight
- Long reception range
- High sensitivity
- Pb free and RoHS compliant
- Compliance with EU REACH

Description

The IRM-6638T devices are DIP type infrared receivers which have been developed and designed by using the latest IC technology.

The PIN diode and preamplifier are assembled onto a lead frame and molded into a black epoxy package which operates as an IR filter.

The demodulated output signal can directly be decoded by a microprocessor.

Applications

- AV equipment such as TV, VCR, DVD, CD, MD, etc.
- Toy applications
- CATV set top boxes
- Multi-media Equipment
- Other devices using IR remote control

Application circuit

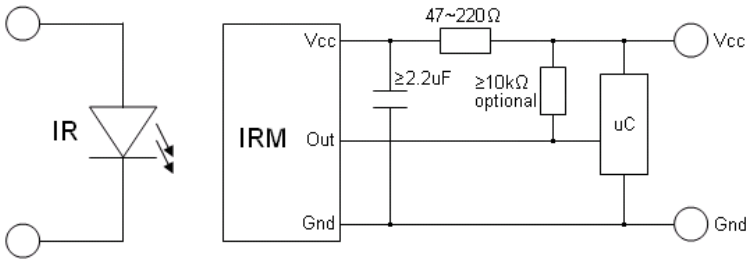

The RC Filter must be connected as close as possible to Vcc and GND pins.

Part number table

Model No.	Carrier Frequency
IRM-6638T	38 kHz

Absolute Maximum Ratings (Ta=25°C) *1

Parameter	Symbol	Rating	Unit
Supply Voltage	V _{cc}	6	V
Operating Temperature	T _{opr}	-20 ~ +80	°C
Storage Temperature	T _{stg}	-40 ~ +85	°C
Soldering Temperature *2	T _{sol}	260	°C

*1 Stresses in excess of the absolute maximum ratings can cause permanent damage to the device. Functional operation of the device is not implied at these or any other conditions in excess of those given in the operational sections of this document. Exposure to absolute maximum ratings for extended periods of the time can adversely affect reliability.

*2 4mm from mold body for less than 5 seconds

Note: DIP class, manual solder temperature to be less than 350 °C, Time to less than 3 seconds

Electro-Optical Characteristics (T_a=25°C, V_{cc}=5V)

Parameter	Symbol	MIN.	TYP.	MAX.	Unit	Condition
Current consumption	I _{cc}	---	0.45	0.70	mA	No input signal
Supply voltage	V _{cc}	2.7	---	5.5	V	
Peak wavelength	λ _p	---	940	---	nm	
Reception range	L ₀	14	---	---	m	See chapter 'Test method' *3
	L ₄₅	6	---	---		
Half angle(horizontal)	φ _h	---	±35	---	deg	
Half angle(vertical)	φ _v	---	±35	---	deg	
High level pulse width	T _H	400	---	800	μs	Test signal according to figure 1 *4
Low level pulse width	T _L	400	---	800	μs	
High level output voltage	V _{OH}	V _{cc} -0.4	---	---	V	I _{SOURCE} ≤ 1μA
Low level output voltage	V _{OL}	---	0.2	0.5	V	I _{SINK} ≤ 2mA

*3 The ray receiving surface at a vertex and relation to the ray axis in the range of θ=0° and θ=45°.

*4 A range from 30cm to the arrival distance. Average value of 50 pulses.

Test method

The specified electro-optical characteristics are valid under the following conditions.

1. Measurement environment

A place without extreme light reflections.

2. External light

The environment contains an ordinary, white fluorescent lamp without high frequency modulation. The color temperature is 2856K and the illumination at the IR receiver is less than 10 Lux ($E_v \leq 10\text{Lux}$).

3. Standard transmitter

The test transmitter is calibrated by using the circuit shown in figure 2. The radiation intensity of the transmitter is adjusted until $V_o=400\text{mVp-p}$. Both the test transmitter and the photo diode have the peak wavelength of 940nm. The photo diode for calibration is PD438B ($\lambda_p=940\text{nm}$, $V_r=5\text{V}$).

4. The measurement system is shown in Fig.-3

Fig.1 Transmitter Wave Form

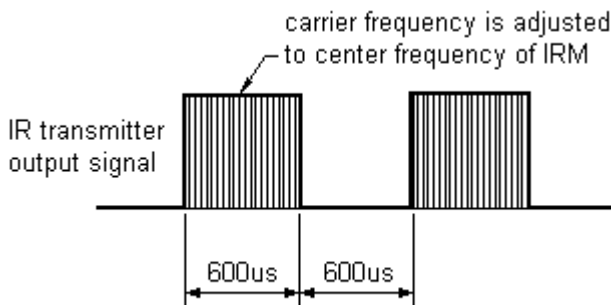

D.U.T output Pulse

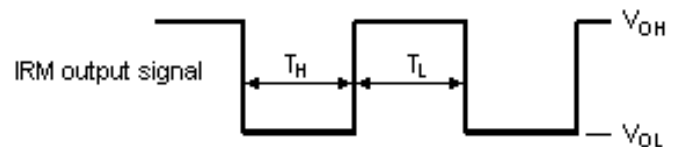

Fig.2 Standard transmitter calibration

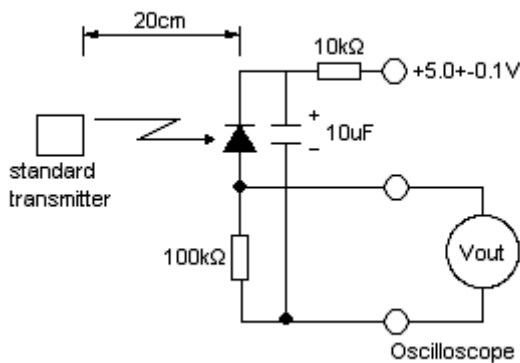
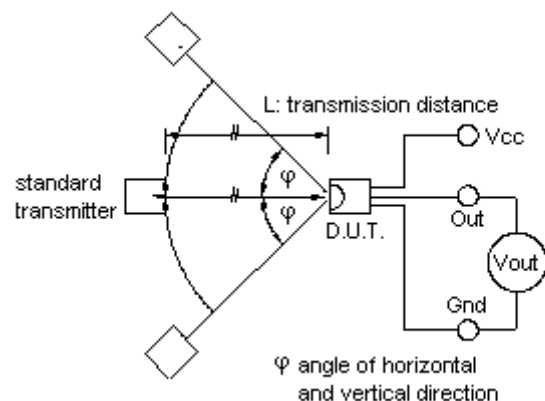

Fig.3 Measuring system



Typical Electro-Optical Characteristics Curves

Fig.4 Relative Responsibility vs. Wavelength

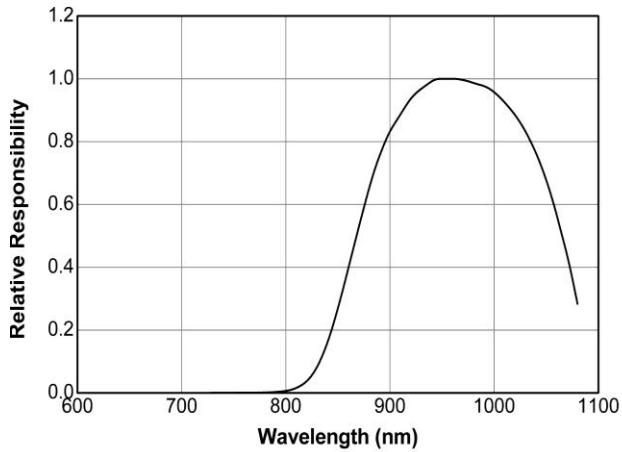

Fig.5 Relative Sensitivity vs. Angle

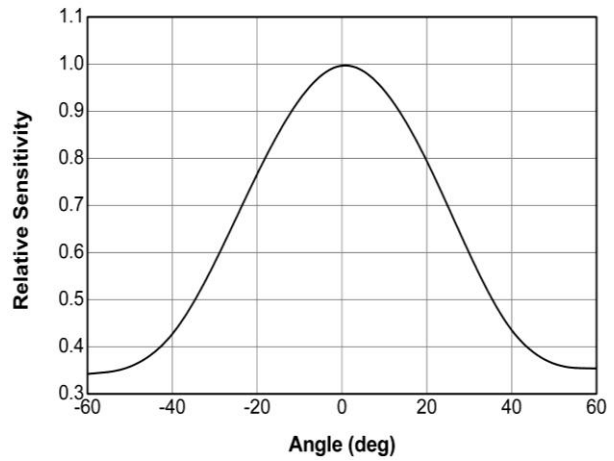

Fig.6 Variation Output Pulse Width vs. Distance

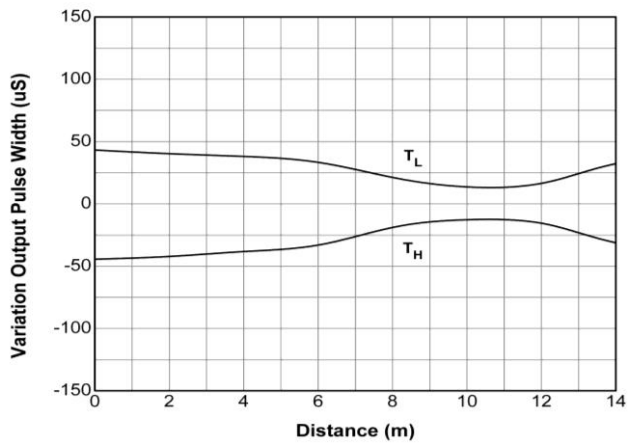

Fig.7 Relative Sensitivity vs. Supply Voltage

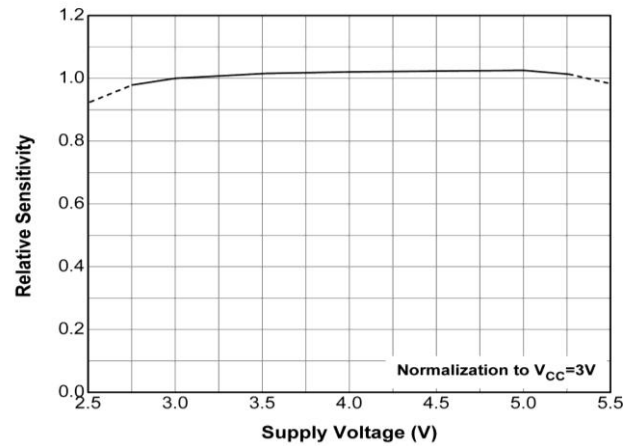
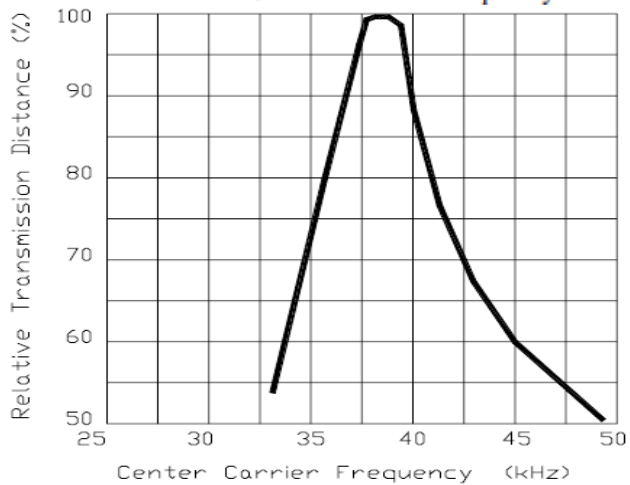
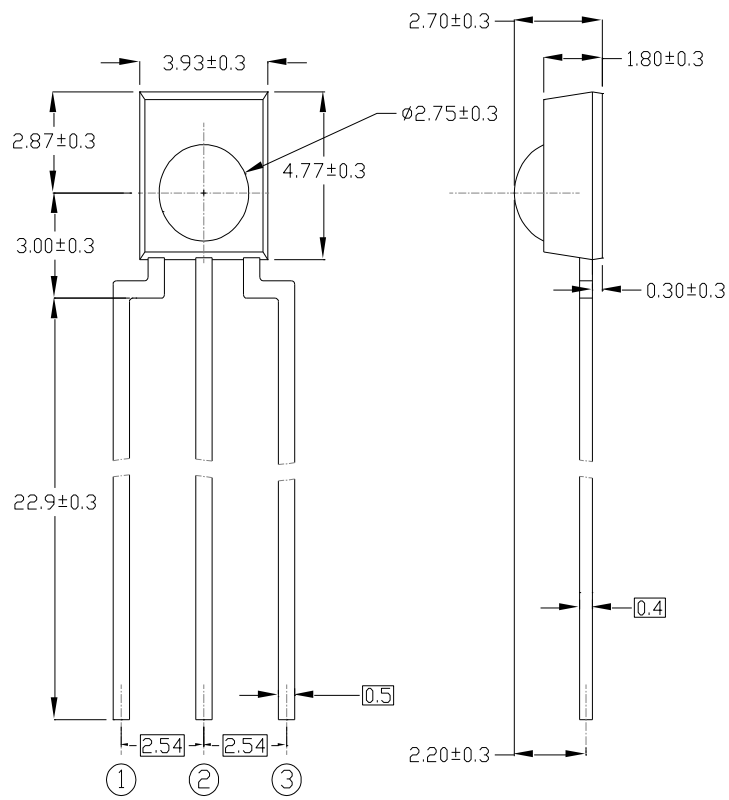

Fig.-8 Relative Transmission Distance vs. Center Carrier Frequency



Package Dimensions
 (Dimensions in mm)



Pin Function

- ①: Vout
- ②: GND
- ③: Vcc

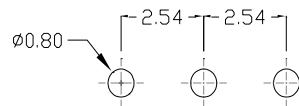
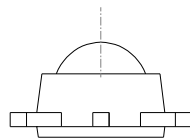

- ① Vout
- ② GND
- ③ Vcc

Notes:

1. All dimensions are in millimeters.
2. Tolerances unless dimensions ± 0.5 mm.
3. Suggested pad dimension is just for reference only.
 Please modify the pad dimension based on individual need.

Code compatibility

Protocol	Suitable	Protocol	Suitable
Matsushita	Yes	Sony 12 bit	Yes
NEC	Yes	Sony 15 bit	No
RC5	Yes	Sony 20 bit	No
RC6 ¹⁾	Yes	Sharp	Yes
Toshiba	Yes	Zenith	Yes
RCA	No	Continuous Code	No

1) RC6 is only compatible if the data low time is 25ms or more.

Device Marking

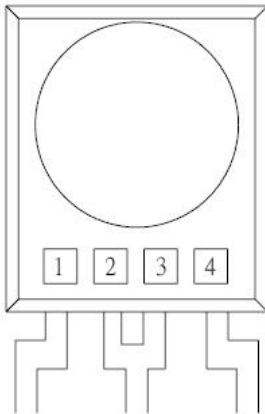

Notes:

- 1 denotes Year code
- 2 denotes Month code
- 3 denotes Device number
- 4 denotes Carrier frequency

Packing Quantity

1500 pcs / Box
 10 Boxes / Carton

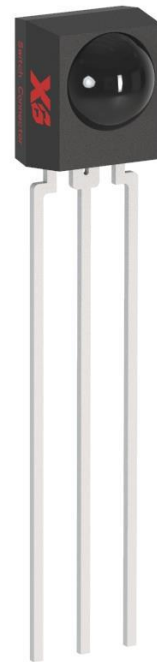

DISCLAIMER

1. XI BNANG reserves the right(s) on the adjustment of product material mix for the specification.
2. The product meets XI BNANG published specification for a period of twelve (12) months from date of shipment.
3. The graphs shown in this datasheet are representing typical data only and do not show guaranteed values.
4. When using this product, please observe the absolute maximum ratings and the instructions for using outlined in these specification sheets. XI BNANG assumes no responsibility for any damage resulting from the use of the product which does not comply with the absolute maximum ratings and the instructions included in these specification sheets.
5. These specification sheets include materials protected under copyright of XI BNANG. Reproduction in any form is prohibited without obtaining XI BNANG's prior consent.
6. This product is not intended to be used for military, aircraft, automotive, medical, life sustaining or life saving applications or any other application which can result in human injury or death. Please contact authorized XI BNANG sales agent for special application request.