

RoHS  
Compliant

ZONE	SYMBOL	REVISION	APPROVAL	DATE
A		INITIAL	Lucky	2021.10.27

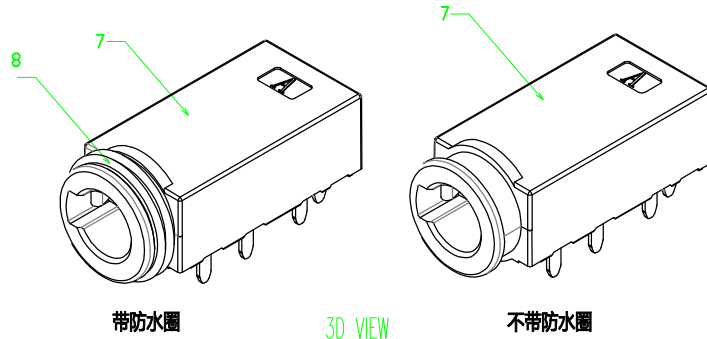
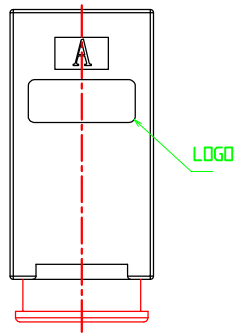

3D VIEW

- CONTACT CURRENT RATING: 1A.
- CONTACT RESISTANCE: 100 mΩ MAX.;
- INSULATION RESISTANCE: 100MΩ MIN.;
- DIELECTRIC WITHSTANDING: 500V AC MIN.;
- DURABILITY: 5,000 CYCLES MIN.;
- CONNECTOR MATING FORCES: 30N MAX.;
- CONNECTOR UNMATING FORCES: 3N MIN.;
- TERPROOF LEVEL: IP67;

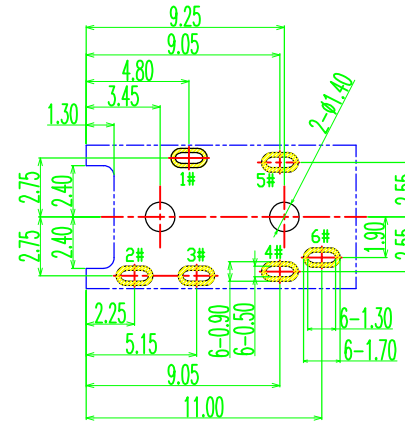
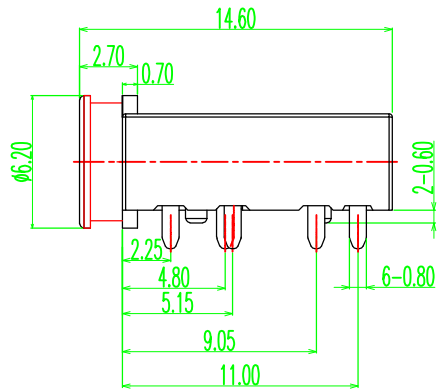
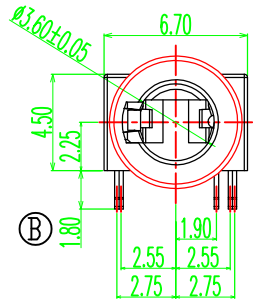

P.C.B LAYOUT T=1.00mm  
TOP VIEW

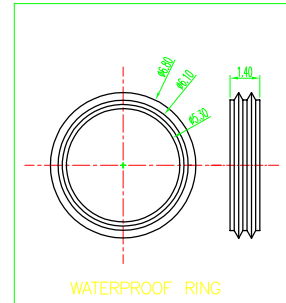

WATERPROOF RING

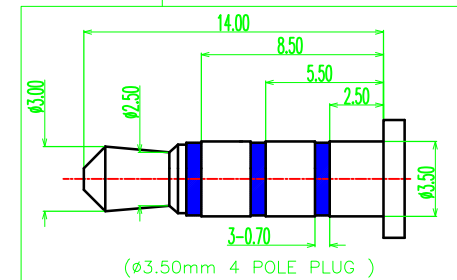

(ø3.50mm 4 POLE PLUG)

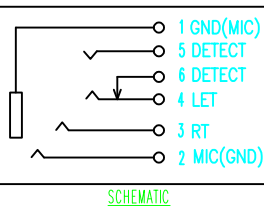
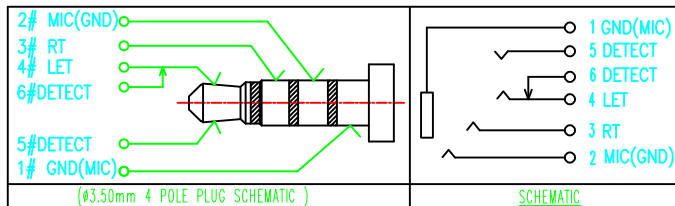
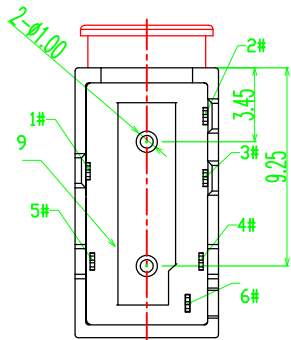

ITEM	NAME	Q'TY	DESCRIPTION	NOTE
9	COVER	1	HIGH TEMPERATURE PLASTIC MATERIALE; COLOR BLACK	
8	WATERPROOF RING	1	SILICA GEL	
7	HOUSING	1	HIGH TEMPERATURE PLASTIC MATERIALE; COLOR BLACK	
6	TERMINAL 6#	1	COPPER ALLOY; NICKEL UNDER PLATING OVERALL;GOLD FLASH PLATING ON SOLDER AREA ;GOLD FLASH PLATING ON CONTACT AREA	T=0.20mm
5	TERMINAL 5#	1	COPPER ALLOY; NICKEL UNDER PLATING OVERALL;GOLD FLASH PLATING ON SOLDER AREA ;GOLD FLASH PLATING ON CONTACT AREA	T=0.20mm
4	TERMINAL 4#	1	COPPER ALLOY; NICKEL UNDER PLATING OVERALL;GOLD FLASH PLATING ON SOLDER AREA ;GOLD FLASH PLATING ON CONTACT AREA	T=0.20mm
3	TERMINAL 3#	1	COPPER ALLOY; NICKEL UNDER PLATING OVERALL;GOLD FLASH PLATING ON SOLDER AREA ;GOLD FLASH PLATING ON CONTACT AREA	T=0.20mm
2	TERMINAL 2#	1	COPPER ALLOY; NICKEL UNDER PLATING OVERALL;GOLD FLASH PLATING ON SOLDER AREA ;GOLD FLASH PLATING ON CONTACT AREA	T=0.20mm
1	TERMINAL 1#	1	STAINLESS STEEL; NICKEL UNDER PLATING OVERALL;GOLD FLASH PLATING ON SOLDER AREA ;GOLD FLASH PLATING ON CONTACT AREA	T=0.20mm

**东莞市溪榜电子有限公司**  
DONG GUAN XI BANG ELECTRONICS CO., LTD.

DESIGN		DATE	2021.10.27	SCALE	1:1
DRAWING	Lucky	DATE	2021.10.27	MATERIAL	*
CHECK	liao Y K	DATE	2021.10.27	DWG. no.	
APPROVAL	Abel	DATE	2021.10.27	SHEET	

PART NAME	3.5mm STEREO JACK	TOLERANCE UNLESS	0.0±0.3	UNIT:	mm
PART NO.	ZB23003-06DBAP-A	OTHERWISE SPECIFIED:	0.00±0.2 0.000±0.15		