

CAD FILE:

ROHS

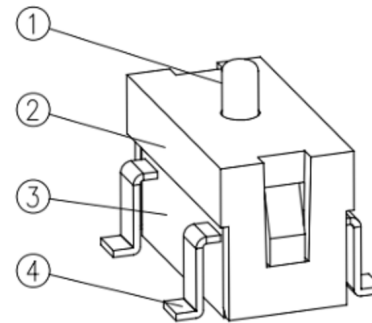
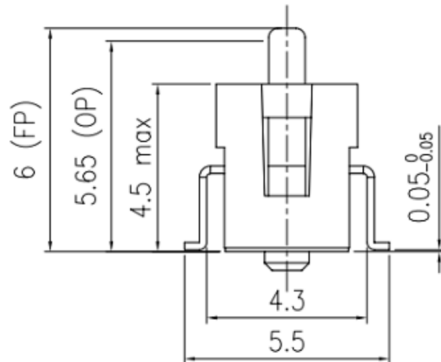
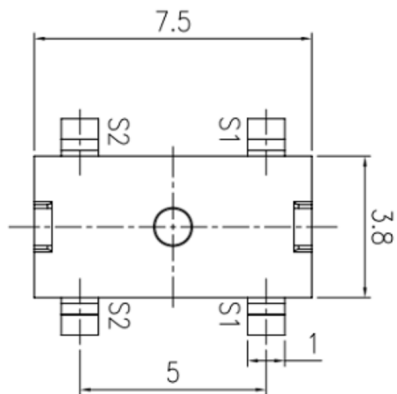

安装孔尺寸图

MOUNTING HOLE DIMENSIONS

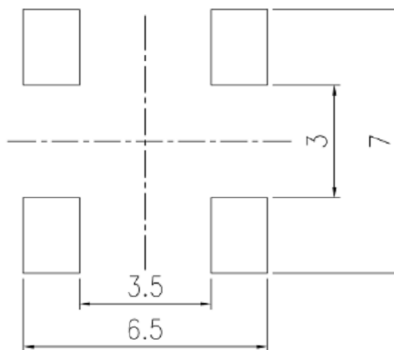
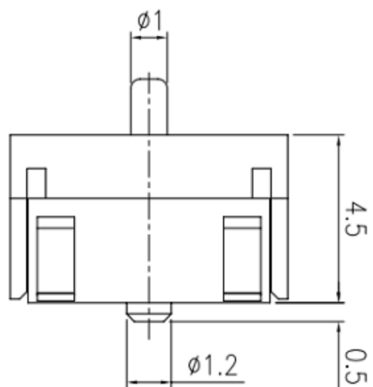

电路图

SCHEMATIC

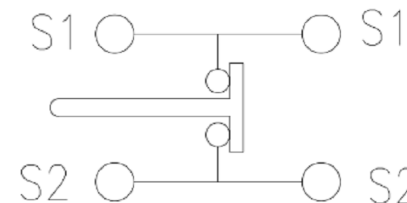

8										
7										
6										
5										
4	CONTACT	SUS	1	Ag CLAD	TOLERANCE UNLESS SPECIFIED					
3	CASE	PPA/BRASS SRTIP	1	BLACK/Ag PLATED	WITHIN 1.5mm : ±0.1mm	A	2012-9-25	初版		ZENQ. CHEN
2	COVER	STEEL STRIP	1	Ni PLATED	OVER 1.5mm : ±0.2mm	ISSUE	DATE	DESCRIPTIONS OF REVISION		APPD.
1	KNOB	PPA	1	BLACK	TITLE : Detection Switch		UNIT : mm	DRWG NO.: XB-TM-7505M		
NO.	PARTS	MATERIALS	Q'TY	FINISH	MODEL: XB-TM-7505M		SCALE: 5:1	DWN.	JUN. YANG	2012-9-25
					 东莞市溪榜电子有限公司 DONG GUAN XI BANG ELECTRONI CS CO., LTD.			CHK'D	DONG. PANG	2012-9-25
								APPD.	ZENQ. CHEN	2012-9-25