

产品规格书 **Product Details specification**

产品名称 Title	File No.	VER	Date	Page
XB-985-15光电开关	XB-3D-985	A2	2021.08.18	1/3

■ 功能Function

1. 水平倾斜检测

Horizontal tilt anti-fall detecting.

2. 垂直翻转检测

Vertical flip anti-fall detecting.

■ 应用产品Applications

1. 智能家用电器 Smart home appliances

2. 倾倒安全防护电路 Tilting safety protection circuit

3. 智能电子设备 Intelligent electronic equipment



■ 产品特性Features:

1. 本产品可作倾斜检测。

This product can do the tilt detecting.

2. 产品直立时输出低电平;当产品向触发方向倾斜且超过 15 ± 8 度, 输出高电平。

When the products is upright, the output is low level. When the products tilt to trigger direction and more than 15 ± 8 degree, output is the high level.

3. 此开关的输出量可触发MCU、I/O等控制电路。

This switch output can trigger MCU, I/O control circuit.

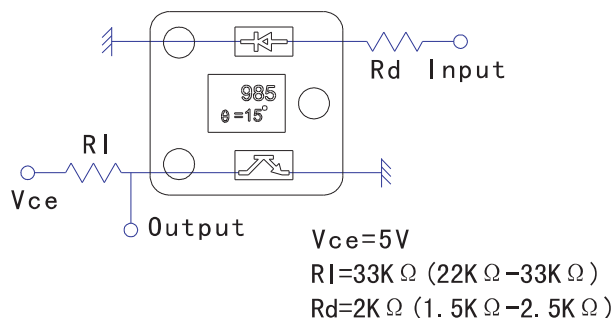
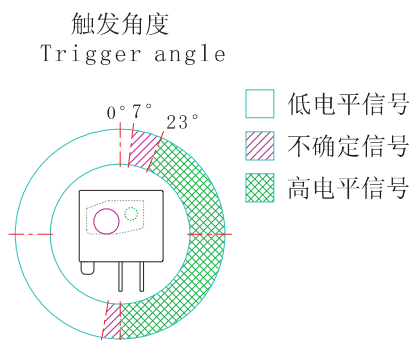



产品规格书 **Product Details specification**

产品名称 Title	File No.	VER	Date	Page
XB-985-15光电开关	XB-3D-985	A2	2021.08.18	2/3

■ 电器特性 Electrical characteristics:

1	电压	Voltage:	4.5-5V
2	电流	Current:	6-10mA
3	导通时间	Conductive time:	连续导通
4	对射管特性	LED characteristics	见附件

■ 可靠测试项目 Reliable test project:

1	操作温度	Operating Temperature	-25°C to 85°C
2	储存温度	Storage Temperature	-40°C to 85°C
3	端子拉力	Pull force of terminal	500gf for 1 minute
4	湿度	Humidity	40°C/95% RH
5	操作寿命	Operating lifespan	1,000,000 times, 2Hz
6	电器寿命	Electrical lifespan	30,000 hours If=10mA, Vce=5V

■ 材料列表 Bill of material:

1	胶座	Housing	Nylon+ Glass fiber
2	胶盖	Plastic	Nylon+ Glass fiber
3	滚珠	Ball	Brass, Nickel/silver/gold-plated
4	发射管	Emissions	
5	接收管	Reliever	

■ 焊接特性 Welding characteristics

1. 手工焊: 330°C ± 10°C, < 3秒.

Manual welding: 330°C ± 10°C, < 3s.

2. 波峰焊接 (DIP): 260°C ± 10°C, < 5秒.

Wave peak soldering (DIP): 260°C ± 10°C, < 5s.

3. 焊锡: 无铅.

Solder tin: lead free.

4. 不可使用强酸、碱性助焊剂.

Do not use strong acid alkali flux.

■ 包装 Packaging:

1、200PCS/袋 (PVC塑料袋, 按一般电子料存放要求存放)
200PCS/bag (PVC plastic)

2、336PCS/box

地址: 广东省东莞市黄江合路工业区

Add: Huangjianghe Road Industrial Zone, Dongguan City, Guangdong Province

TEL: 0769-82055138

82056828

Fax: 0769-83663452

http://www.alpsr.cn

www.alpsr.com

E-mail: XB@ALPSR.CN

产品规格书 Product Details specification

产品名称 Title	File No.	VER	Date	Page
XB-985-15光电开关	XB-3D-985	A2	2021.08.18	3/3

SIZE尺寸

Unit: mm,
Tolerance ± 0.25

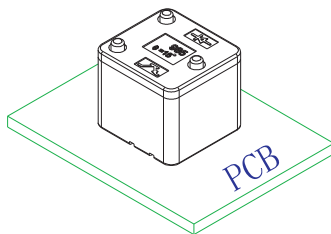

水平安装

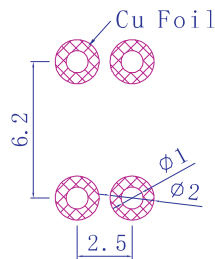

PCB Hole Layout

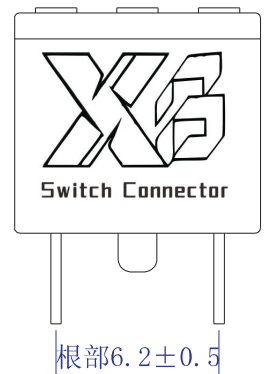
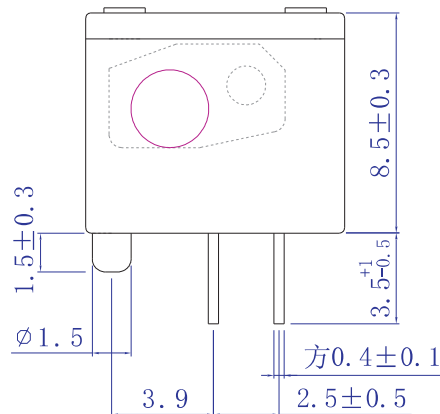
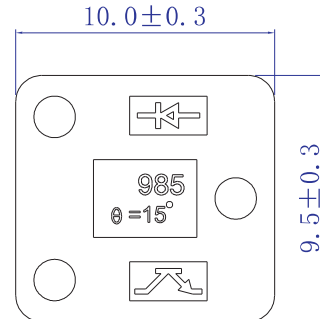

注意事项Note

1.If the product used for high security products and durability of extremely high equipment (such as life safety equipment, aviation facilities, disaster prevention device), please confirm whether a share, can seek advice our company for details.

如果该产品要用于高安全性产品及耐久性极高的设备中（如生命安全设备、航空设施、防灾装置），请确认是否合用，或咨询我司了解详情。

2.In case of fire, Please do not overload applicable.

请勿超负荷使用，以防发生火灾。

3.The welding temperature or time more than standard, can cause switch collapse.

焊接温度或时间超过规范时，会造成开关解体。

4.Do not use water solubility flux. May cause damage to the switch.

勿使用水溶性助焊剂、可能会造成开关损坏。

5.Do not use solvent wash switch.

勿使用溶剂清洗开关。

6.Xibang company is only responsible for the defective problems of the product itself, return and exchange the defective products, and does not bear other joint and several expenses.

溪榜公司只承担本产品本身不良问题,对不良品进行退换货,不承担其它连带费用责任。