

FRONT VIEW

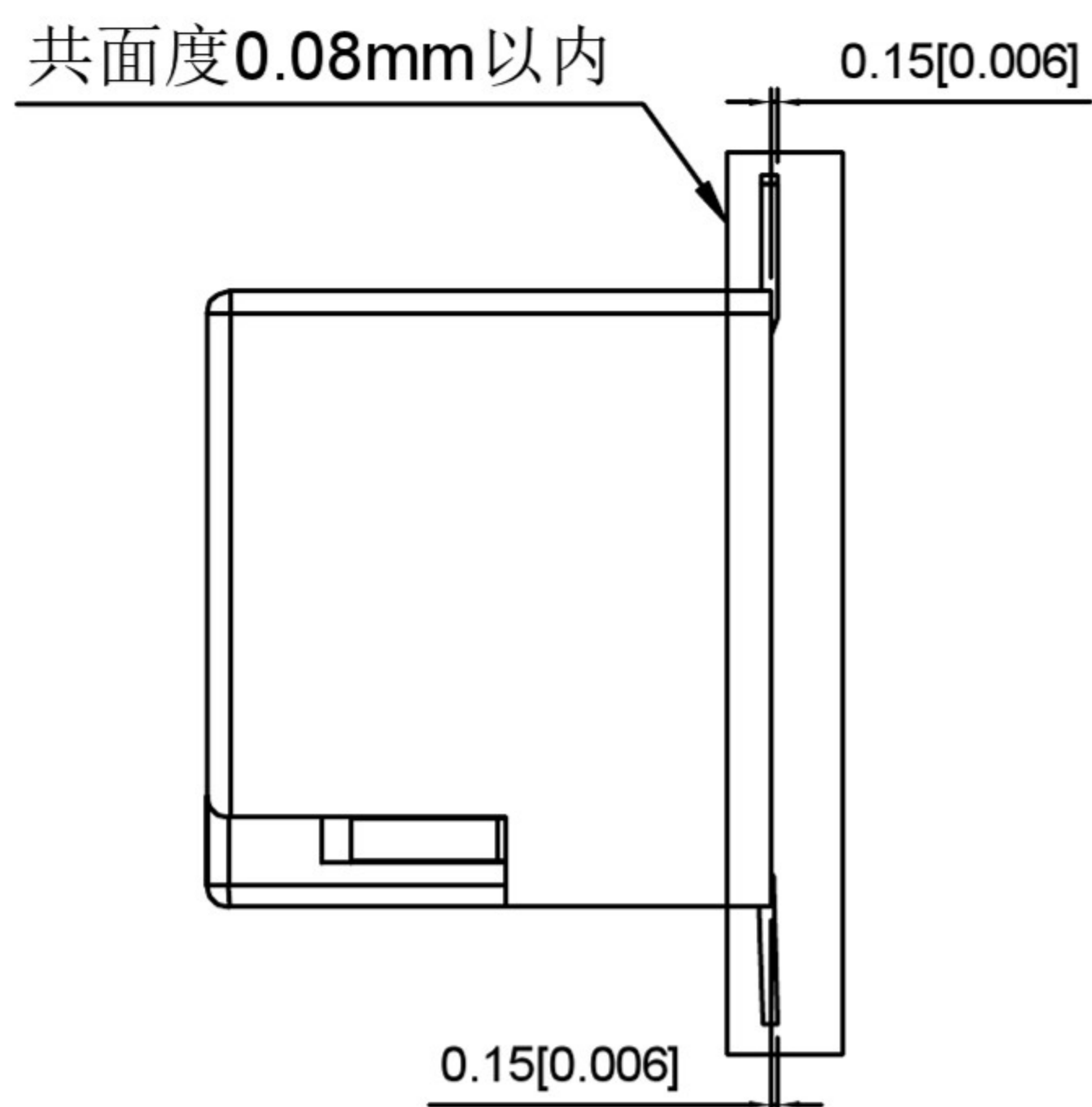

RIGHT SIDE VIEW

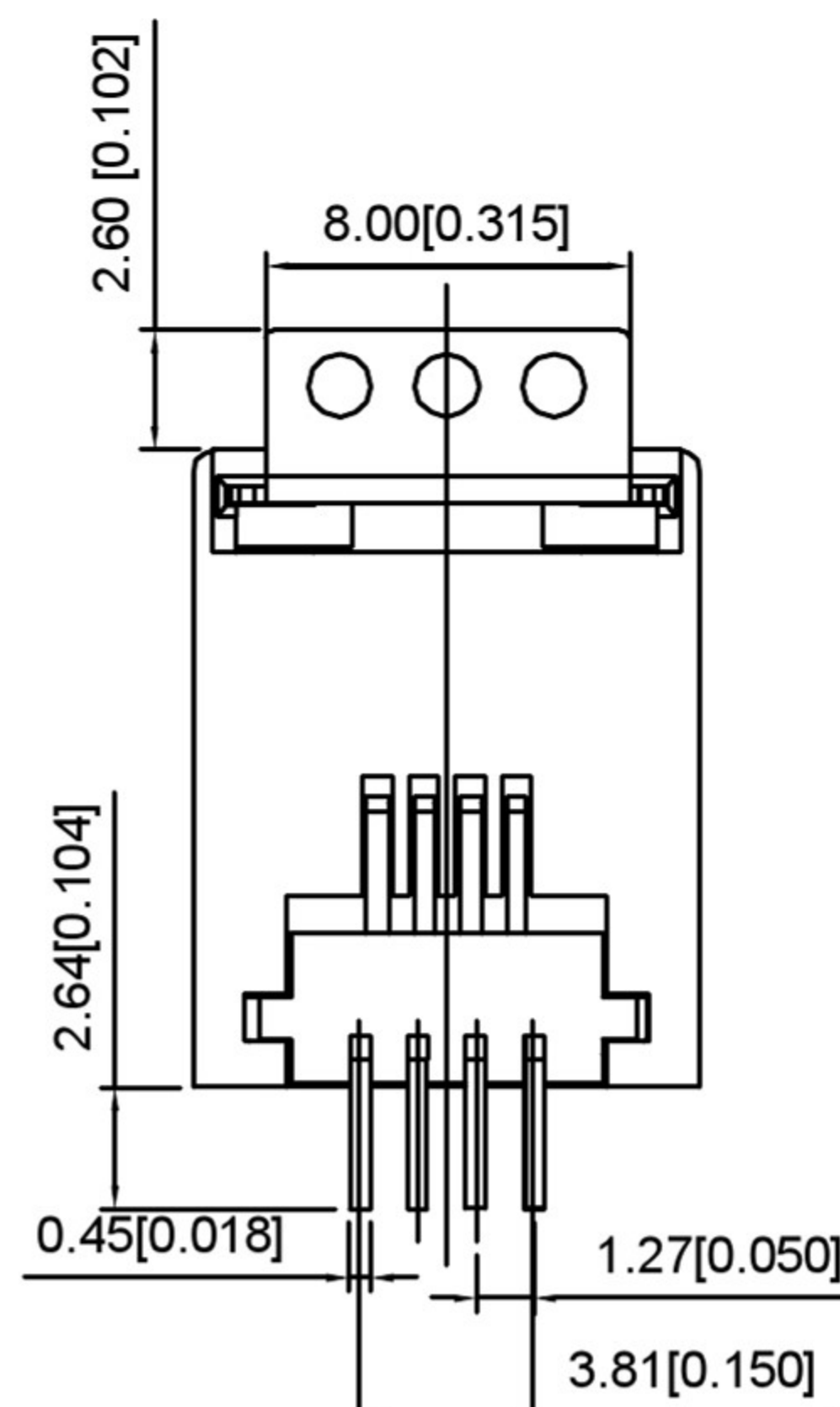

BACK VIEW

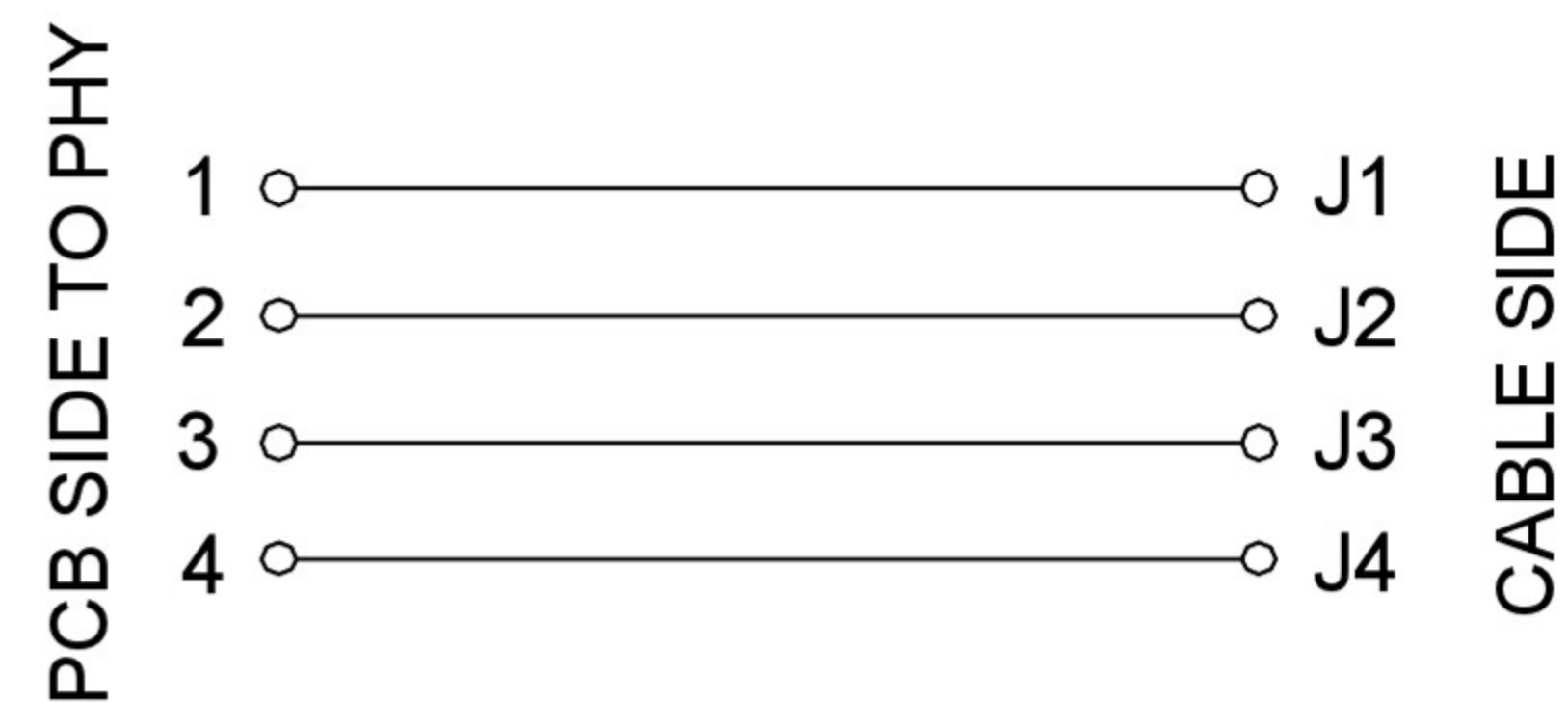

MATERIAL 材料:
 HOUSING 外壳: LCP,UL94V-0,BLACK.
 TERMINAL 端子: PHOSPHOR,BRONZE T=0.35MM
 GOLD PLATING ON CONTACT AREA.

MECHANICAL 机械:
 DURABILITY 耐用性: 750 CYCLES MIN,12.5MM/MINUTE.
 INSERTION FORCE 插入力:2.2KG.F MAX
 RETENTION STRENGTH 保持力:7.7KG.F BETWEEN JACK AND PLUG.
 OPERATING TEMPERATURE 工作温度: -40°C~+85°C.
 STORAGE TEMPERATURE 储存温度: -40°C~+85°C.
 ALL CRITICAL DIMENSIONS WITH "**"

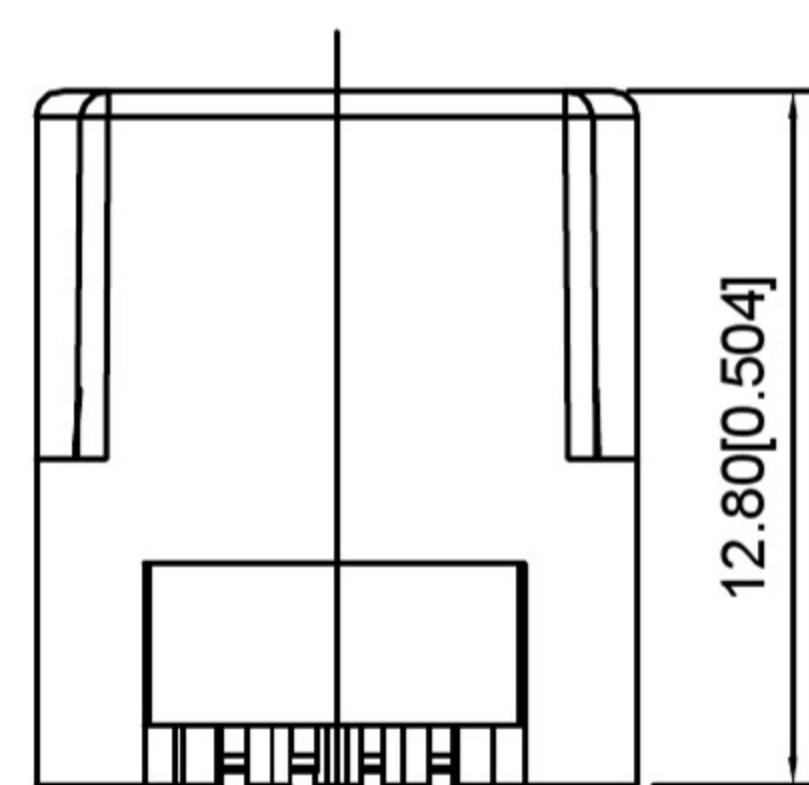

ELECTRICAL 电气:
 VOLTAGE 电压: 125 VOLTS AC.
 CURRENT RATING 电流额定值: 1.5AMP.
 DIELECTRIC STRENGTH 介电强度: 1000 VAC RMS 50HZ OR 60HZ,1 MIN
 INSULATION RESISTANCE 绝缘电阻: 500 MEGA OHMS MIN.INITIAL
 AFTER 500V DC FOR 1 MINUTE.
 CONTACT RESISTANCE 接触电阻:SINGLE TERMINAL 30 MILLIOHMS MAX.
 INITIAL 50 MILLIOHMS MAX. AFTER
 DURABILITY TEST.

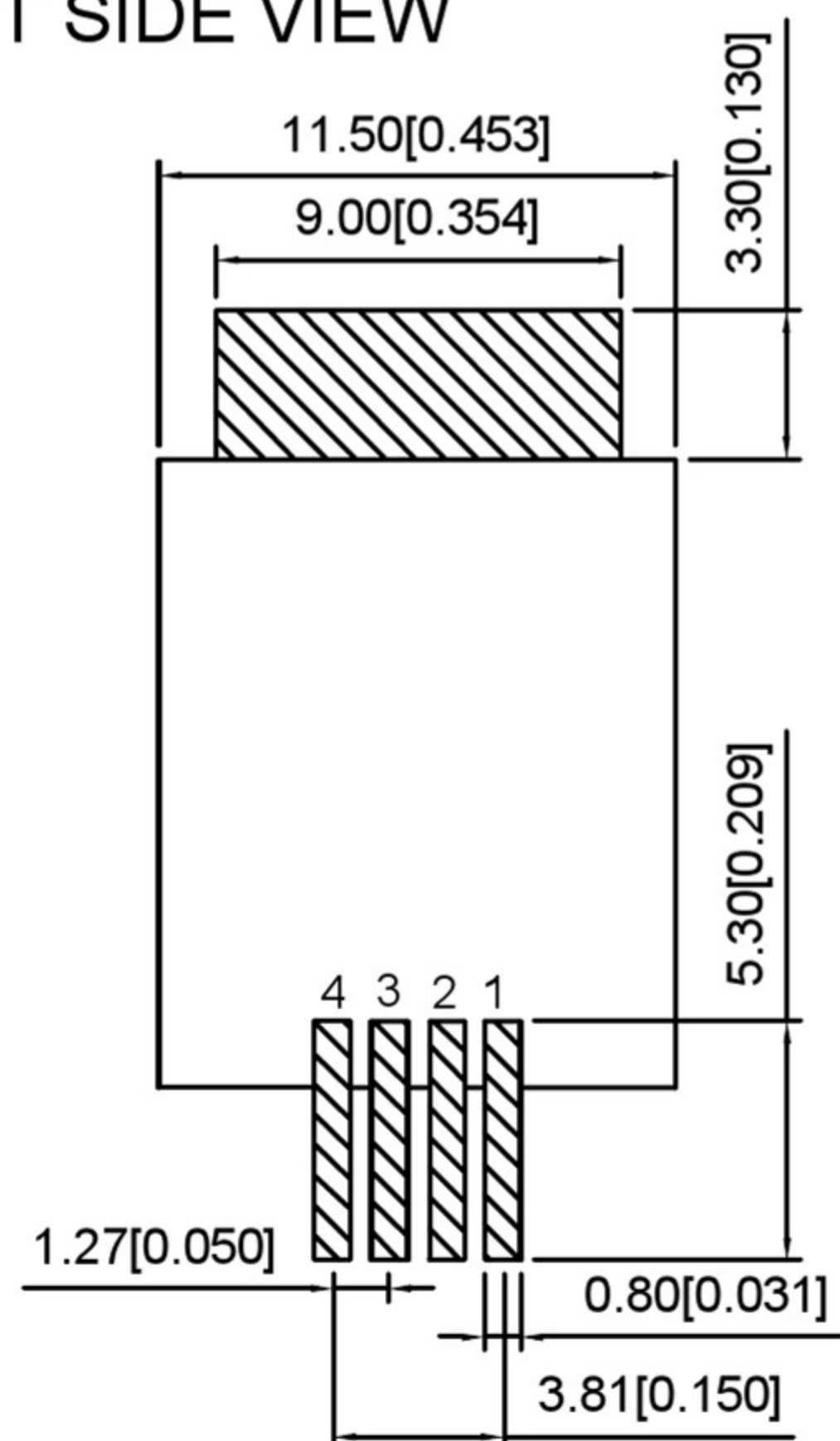

BOTTOM VIEW



RECOMMENDED PCB LAYOUT
 VIEWED FROM COMPONENT SIDE

				ANGULAR	±5°		DSND	SCALE: N/A	MODEL TYPE: RJ11		
				L ≤ 4	±0.2		DWN	VIEW: 	PART NO.:		
				4 < L ≤ 16	±0.3		CHKD	UNIT: mm/in	DWG NO.:		
				16 < L ≤ 63	±0.4		APPD	SIZE: A4	XB-X35AKIWW6SB3009		
				L > 63	±0.5						
REVISIONS				UNSPECIFIED TOLERANCES		DONG GUAN XI BANG ELECTRONIC CO., LTD			WEIGHT	SHEET	REVISION
www.alpsr.com www.gdxjdz.com www.xbswitch.com									1/1	A0	