

REVISION A

RoHS Compliant

SYMB	REVISION	DATE	APVD.

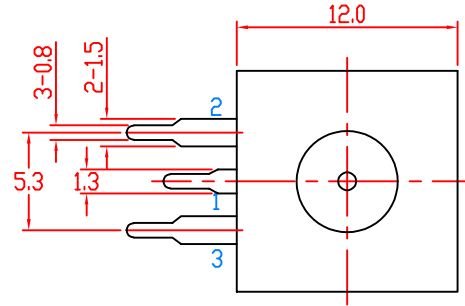

Part Number	Case
XB-TPS-13D07	Without Embossed
XB-TPS-13D07	With Embossed

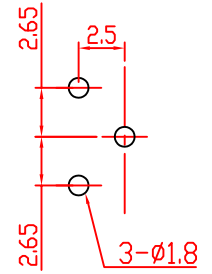

P.C. BLAYOUT

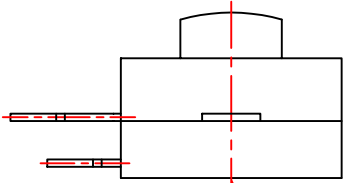

Without Embossed Case

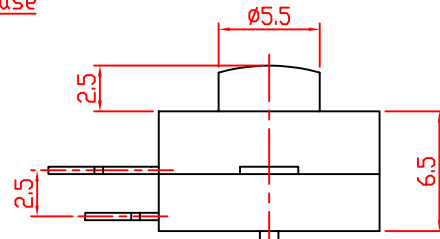
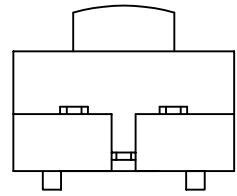

(E) Embossed Case

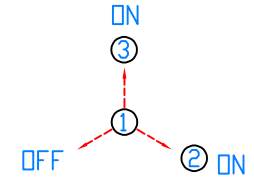
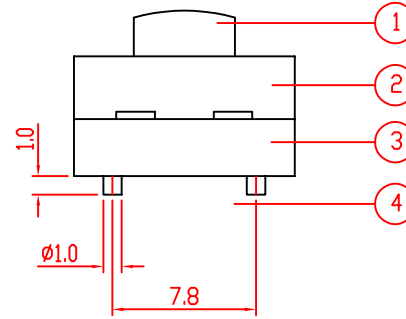

CIRCUIT

160620110

TITLE	TORCH SWITCH		DRAWN	L.Liu		TOLERANCE OTHERWISE UNLESS SPECIFIED		9				
PART NO.	XB-TPS-13D07		CHECKED	G.C.Chen		UP TO 5	±0.2	8				
DRAW NO.	P251		APPROVED	H.K.Lai		ABOVE 5 ~ 30	±0.3	7				
SCALE	5:2	UNIT	mm	DATE	16-06-2011	ABOVE 30 ~ 50	±0.4	6				
						ABOVE 50	±0.5	5				
						ANGLE	±3°	4	TERMINAL	BRASS STRIP	3	Ag PLATED
								3	HOUSING	POM	1	BLACK
								2	COVER	POM	1	BLACK
								1	KNOB	POM	1	BLACK
								NO.	PARTS	MATERIAL	QTY.	FINISHING

XGB 东莞市溪榜电子有限公司
DONG GUAN XI BANG ELECTRONICS CO., LTD.

