

F

E

D

C

B

A

RoHS  
Compliant

SYMBOL	REVISION	APPROVAL	DATE

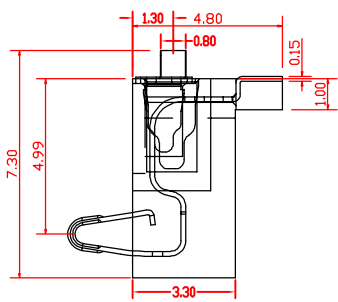
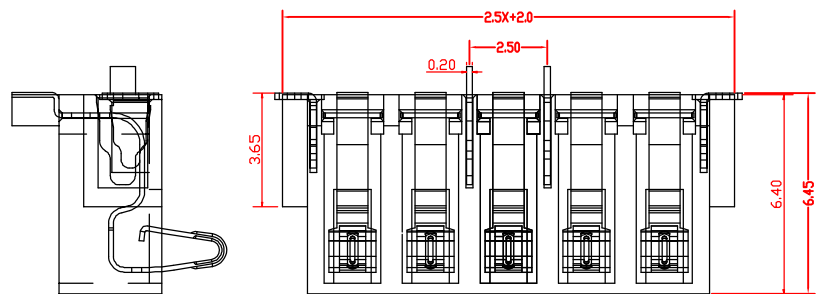
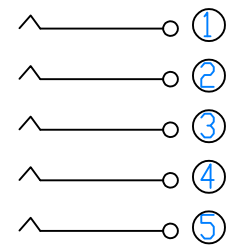
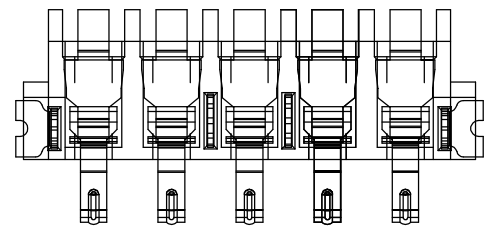

CIRCUIT

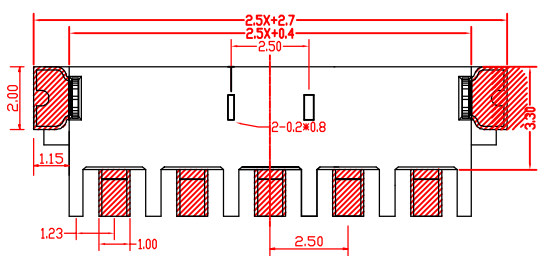
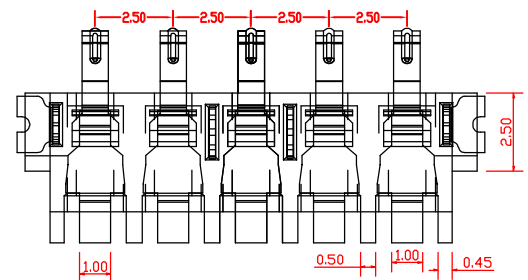

PCB LAYOUT (5pin)

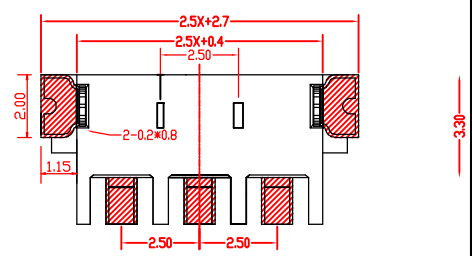

PCB LAYOUT (3pin)

3	PEG	BRASS	1	Sn PLATED
2	HOUSING	LCP	1	BLACK
1	TERMINAL	C5210	X	Au PLATED
NO.	PARTS	MATERIAL	QTY.	FINISHING

**东莞市溪榜电子有限公司**  
DONG GUAN XI BANG ELECTRONICS CO., LTD.

COPYRIGHT RESERVED, PLEASE DO NOT COPY.

PART NAME		CONNECTOR		DRAWING	J,Yang	DWG.No.	SBICL
PART NO.		XB-BC-25S-5P		CHECK	ZENQ.Chen	REV.	A1
UNIT : mm	TOLERANCE	UP TO 5	±0.2	APPROVAL	SCALE	DATE	14-03-2017
	OTHERWISE	ABOVE 5 ~30	±0.3			PAGE	1 OF 1
		ABOVE 30	±0.5				
		ANGLE	±3°				

F

E

D

C

B

A